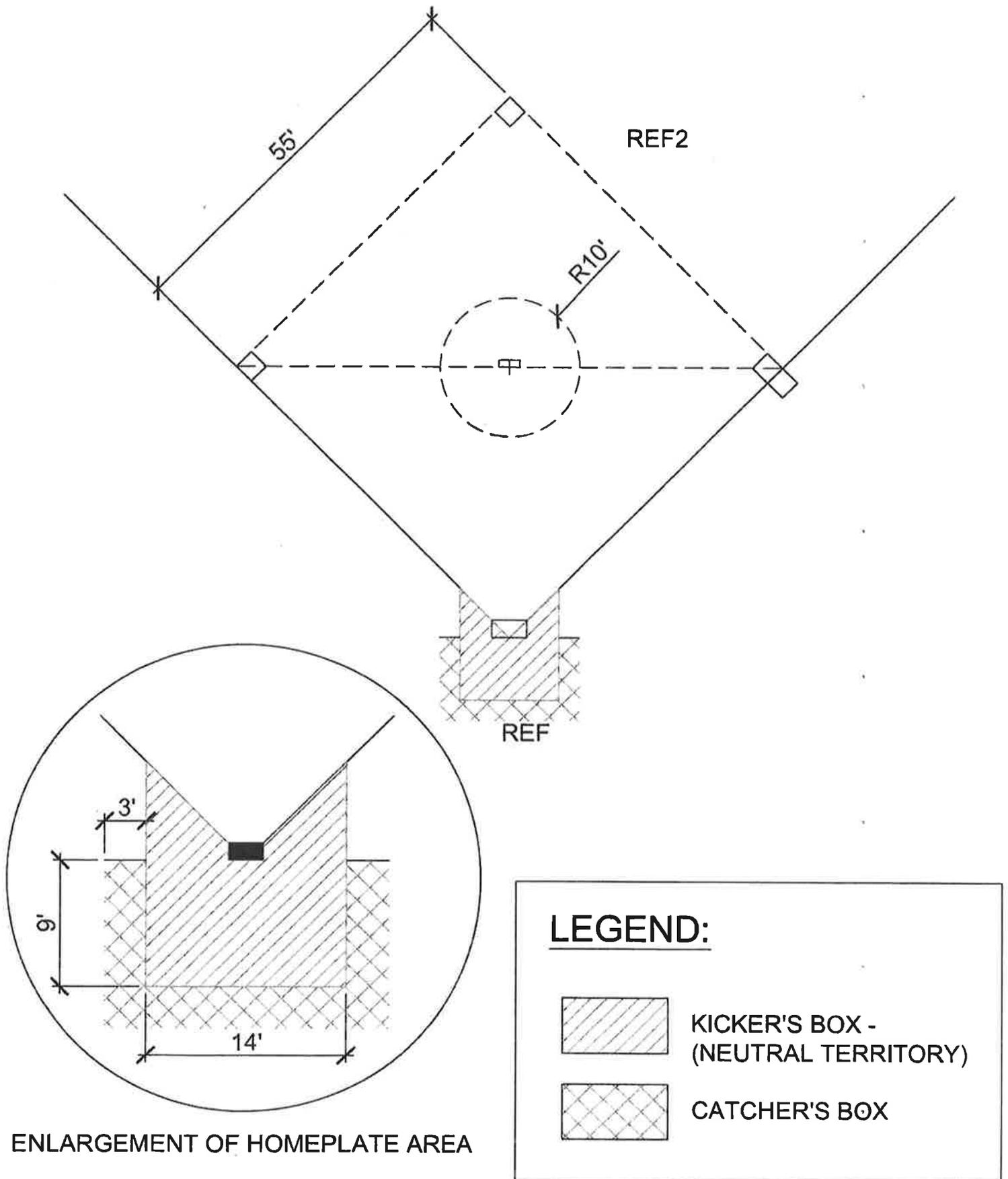
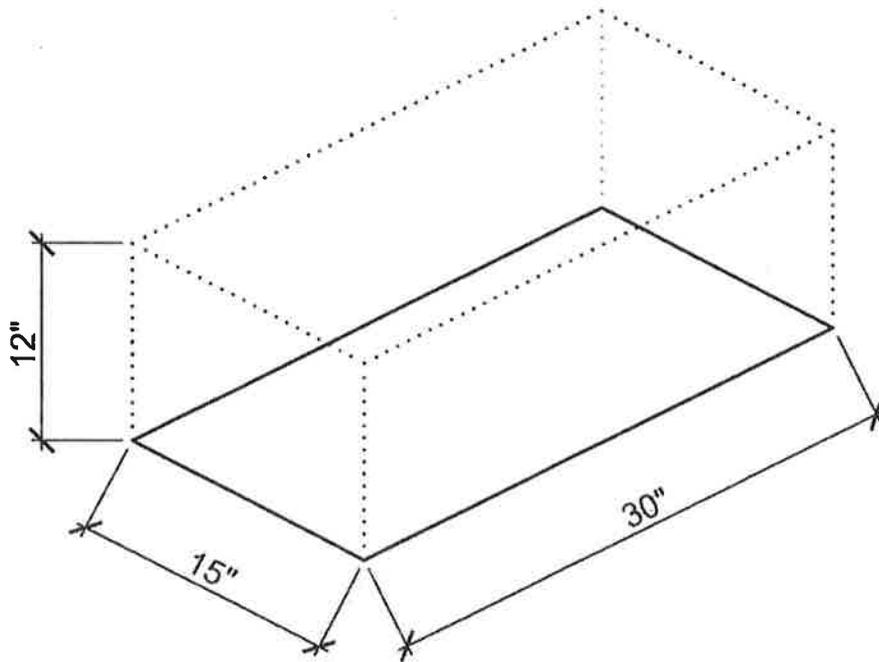

DIAGRAM 1 GSK FIELD DIMENSIONS



ENLARGEMENT OF HOMEPLATE AREA

DIAGRAM 2
GSK STRIKE ZONE



ANY PART OF THE BALL PASSING THROUGH
ANY PART OF THE STRIKE ZONE, AFTER
BOUNCING TWICE, IS CONSIDERED A STRIKE.

DIAGRAM 3 GSK FAIR / FOUL EXAMPLES

FAIR FLY BALLS

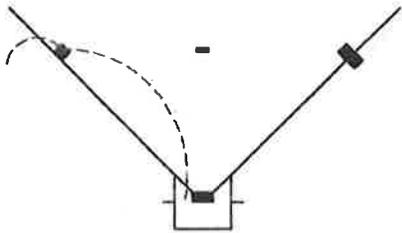

EXAMPLE 'A'

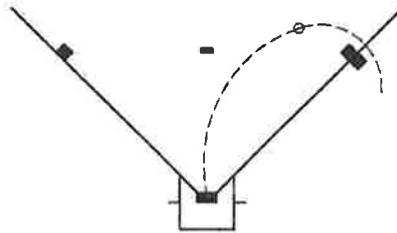

EXAMPLE 'B'

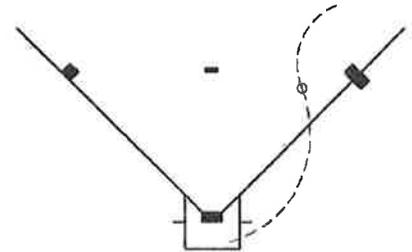

EXAMPLE 'C'

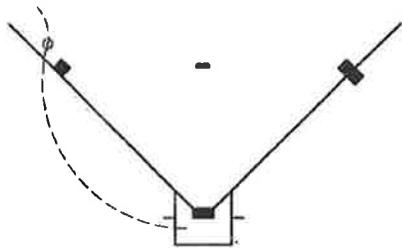

EXAMPLE 'D'

FAIR GROUND BALLS

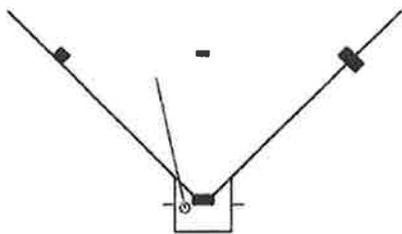

EXAMPLE 'E'

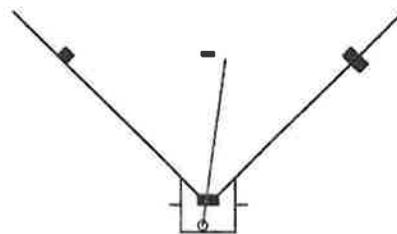

EXAMPLE 'F'

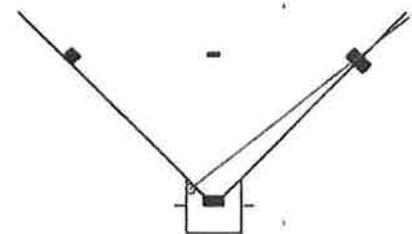

EXAMPLE 'G'

LEGEND:

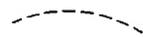

PATH OF BALL IN AIR



PATH OF BALL ON GROUND



FIRST CONTACT POINT WITH GROUND

DIAGRAM 3 GSK FAIR / FOUL EXAMPLES

FOUL FLY BALLS

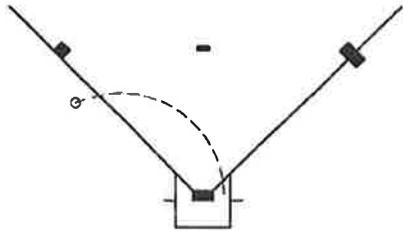

EXAMPLE 'H'

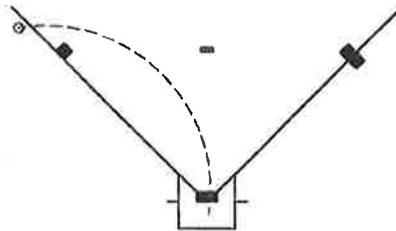

EXAMPLE 'I'

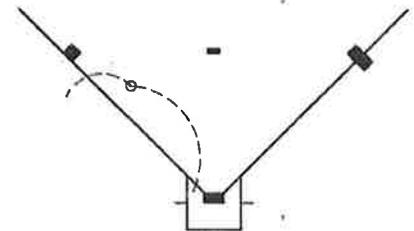

EXAMPLE 'J'

FOUL GROUND BALLS

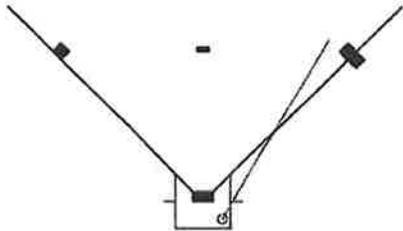

EXAMPLE 'K'

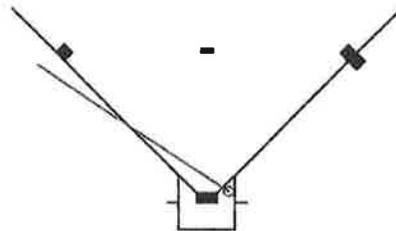

EXAMPLE 'L'

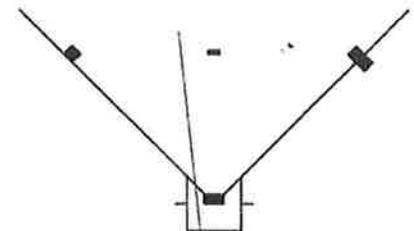

EXAMPLE 'M'

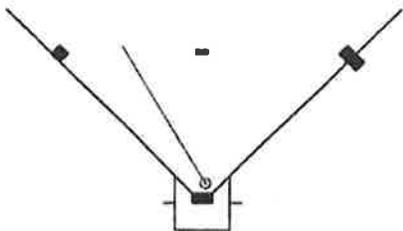

EXAMPLE 'N'

LEGEND:

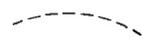
-  PATH OF BALL IN AIR
-  PATH OF BALL ON GROUND
-  FIRST CONTACT POINT WITH GROUND